



IR TV/VCD TRANSMITTER
IR CONTROL IC

GENERAL DESCRIPTION 功能敘述

The M3014 is a remote control transmitter ASIC for TV, VTR, etc. It has a total of 448 commands which are divided into 7 sub-system groups with 64 commands each. The sub-system code may be selected by a press button, a slider switch or hard wired.

FEATURES 產品特長

- Flashed or modulated transmission (default modulated mask option)
- Flashed pulses require a wide band preamplifiers within the receiver
- 7 sub-system addresses
- Up to 64 commands per sub-system address
- Key release detection by toggle bits
- A 455KHz ceramic resonator or crystal

APPLICATIONS 產品應用

Audio equipment, TV, VTR, cassette desks etc..

BLOCK DIAGRAM 功能方塊圖

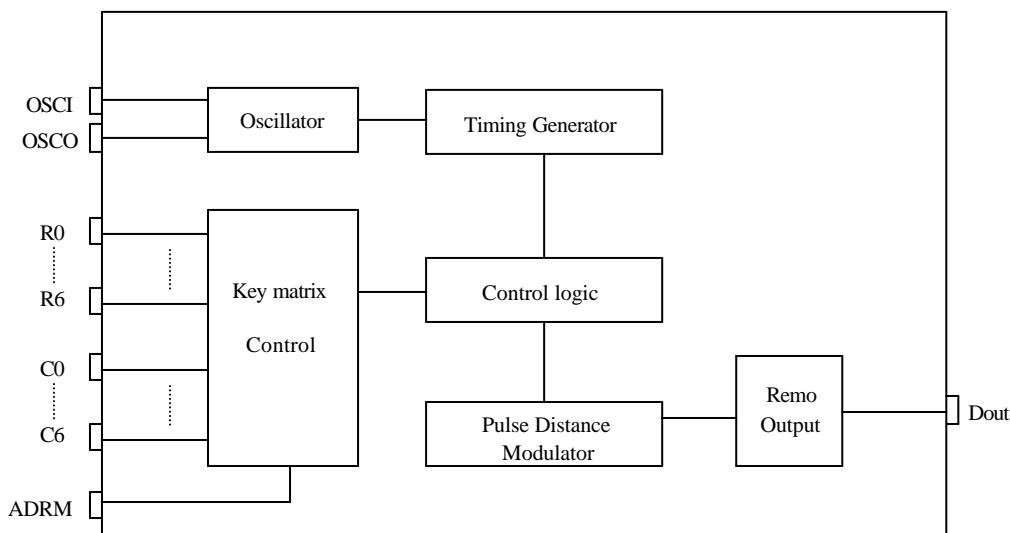

*All specs and applications shown above subject to change without prior notice.
(以上電路及規格僅供參考,本公司得逕行修正)



IR TV/VCD TRANSMITTER
IR CONTROL IC

IR CONTROL

M3014

ABSOLUTE MAXIMUM RATING

(TA=25)

Parameter	Rating	Unit
Supply Voltage	6	V
Input Voltage	-0.3~V _{DD}	V
Operating Temperature	0 to 60	
Storage Temperature	-25 to +125	

ELECTRICAL CHARACTERISTICS

(V_{DD}=3V unless otherwise specified)

Characteristics	Sym.	Min.	Typ.	Max.	Unit	REMARKS
Operating Voltage	V _{DD}	2	3	5.5	V	
Quiescent Current	I _{SB}		0.25	1	μ A	
Operating Current	I _{OP}		0.3	1	mA	No load
Output Drive Current	I _O	1	1.5		mA	@ V _{DS} =1V
Switch Input Current	I _{SB}			100	μ A	
Input Voltage	V _{IH}	V _{DD} -0.2	V _{DD}	V _{DD}	V	
	V _{IL}	V _{SS}	V _{SS}	V _{SS} +0.2		
Oscillator Frequency	F _{osc}		455		KHz	(Cer resonator)

PIN DESCRIPTION

No.	Pin name	Description
1	DOUT	Serial data output pin
2~8	C6~C0	Column control for keyboard matrix
9	ADRM	Address mode input pin
10	VSS	Negative power supply
11	OSCO	Oscillator output
12	OSCI	Oscillator input
13~19	R0~R6	Row control for keyboard matrix
20	VDD	Positive power supply

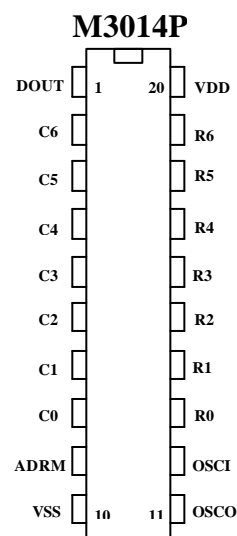



IR TV/VCD TRANSMITTER
IR CONTROL IC

FUNCTION DESCRIPTION

Keyboard operation

In the stand-by mode R0 to R6 are on (pull low). Whenever a key is pressed, one or more of the C0~C6 are tied to VSS. This will start the power-up sequence. First the oscillator is activated and after the debounce time t_{DB} (see figure 2),the output drivers (R0 ~ R6) become active successively.

Within the first scan cycle the transmission mode, the applied sub-system address and the selected command code are sensed and loaded into an internal data latch.

In contrast to the command code, the sub-system is sensed only within the first scan cycle. If the applied sub-system address is changed while the command key is pressed, the transmitted sub-system address is not altered.

Multiple key- stroke

There are two restriction caused by the special structure of the keyboard matrix:

The keys switching to VSS (code numbers 7, 15, 23, 31, 39, 47, 55 and 63) and the keys connected to C5 and C6 are not covered completed by the multiple key protection. If one sense input is switched to VSS, fourth keys on the same sense line are ignored , i.e. the command code corresponding to “ key to VSS ” is transmitted.

C5 and C6 are not protected against multiple key – stroke on the same row driver line, because this condition has been used for the definition of additional code (code number 56 to 63).

Output Sequence

The output operation will start when the selected code is found. A burst of pulses , including the latched address and command codes , is generated at the output Dout as a key is pressed. The format of the output pulse train is given in Figure 1. The operation is terminated by releasing the key or if more than one key is pressed at the same time. Once a sequence is started the transmitted data words will always be completed after the key is released.

The toggle bits T0 and T1 are incremented if the key is released for a minimum time T_{REL} . The toggle bit remain unchanged within a multiple key-stroke sequence.



IR TV/VCD TRANSMITTER
IR CONTROL IC

Table 1 : Pulse Train Timing

Mode	T _O (ms)	tp (μs)	t _M (μs)	t _{ML} (μs)	t _{MH} (μs)	t _w (ms)
Flashed	2.53	8.8				121
Modulated	2.53		26.4	17.6	8.8	121

Fosc	455KHz	t _{osc} = 2.2 μs
tp	4 x t _{osc}	Flashed pulse width
t _M	12 x t _{osc}	Modulation period
t _{ML}	8 x t _{osc}	Modulation period low
t _{MH}	4 x t _{osc}	Modulation period high
t _w	55296 x t _{osc}	Word distance
T _O	1152 x t _{osc}	Basic unit of pulse distance

The following number of pulses may be selected by Metal option : N = 8 , 12 , 16.

Note : The different dividing ratio for To and t_w between flash mode and carrier mode is obtained by changing the module of a particular divider by 3 during flash mode to divide by 4 during carrier mode. This allows the use of a 600KHz ceramic resonator during carrier mode to obtain a better noise immunity for the receiver without a significant change in To and t_w. For first samples, the correct divider ration is obtained by a metal mask option. For final parts, this is automatically done together with the selection of flash- / carrier mode.

Table 2 : Pulse Train Separation (tb)

Code	tb
Logic " 0 "	2 x To
Logic " 1 "	3 x To
Toggle bit time	2 x To or 3 x To
Reference time	3 x To

Table 3 : Transmission mode and sub-system address selection. The sub-system address and the transmission mode are defined by connecting the ADRM input to one or more driver outputs (R0 to R6) of the key matrix. If more than one driver is connected to ADRM, they must be decoupled by diodes.

Mode	Sub-system address				Driver R0 ~ R6						
	#	S2	S1	S0	0	1	2	3	4	5	6
Flashed	0	1	1	1							0
	1	0	0	0	0						0
	2	0	0	1		0					0
	3	0	1	0			0				0
	4	0	1	1				0			0
	5	1	0	0					0		0
	6	1	0	1						0	0
Modulated	0	1	1	1							
	1	0	0	0	0						
	2	0	0	1		0					
	3	0	1	0			0				
	4	0	1	1				0			
	5	1	0	0					0		
	6	1	0	1						0	

O = Connected to ADRM

Blank = not Connected to ADRM



IR TV/VCD TRANSMITTER
IR CONTROL IC

Table 4 :

KEY CODE									DATA CODE							
KEY	R0	R1	R2	R3	R4	R5	R6	VSS	Cn	A	B	C	D	E	F	
K0	O								C0	0	0	0	0	0	0	
K1		O								1	0	0	0	0	0	0
K2			O							0	1	0	0	0	0	0
K3				O						1	1	0	0	0	0	0
K4					O					0	0	1	0	0	0	0
K5						O				1	0	1	0	0	0	0
K6							O			0	1	1	0	0	0	0
K7								O		1	1	1	0	0	0	0
K8	O								C1	0	0	0	1	0	0	
K9		O								1	0	0	1	0	0	0
K10			O							0	1	0	1	0	0	0
K11				O						1	1	0	1	0	0	0
K12					O					0	0	1	1	0	0	0
K13						O				1	0	1	1	0	0	0
K14							O			0	1	1	1	0	0	0
K15								O		1	1	1	1	0	0	0
K16	O								C2	0	0	0	0	1	0	
K17		O								1	0	0	0	1	0	0
K18			O							0	1	0	0	1	0	0
K19				O						1	1	0	0	1	0	0
K20					O					0	0	1	0	1	0	0
K21						O				1	0	1	0	1	0	0
K22							O			0	1	1	0	1	0	0
K23								O		1	1	1	0	1	0	0
K24	O								C3	0	0	0	1	1	0	
K25		O								1	0	0	1	1	0	0
K26			O							0	1	0	1	1	0	0
K27				O						1	1	0	1	1	0	0
K28					O					0	0	1	1	1	0	0
K29						O				1	0	1	1	1	0	0
K30							O			0	1	1	1	1	0	0
K31								O		1	1	1	1	1	0	0



IR TV/VCD TRANSMITTER
IR CONTROL IC

KEY CODE									DATA CODE							
KEY	R0	R1	R2	R3	R4	R5	R6	VSS	Cn	A	B	C	D	E	F	
K32	O								C4	0	0	0	0	0	1	
K33		O								1	0	0	0	0	0	1
K34			O							0	1	0	0	0	0	1
K35				O						1	1	0	0	0	0	1
K36					O					0	0	1	0	0	0	1
K37						O				1	0	1	0	0	0	1
K38							O			0	1	1	0	0	0	1
K39								O		1	1	1	0	0	0	1
K40	O								C5	0	0	0	1	0	1	
K41		O								1	0	0	1	0	1	
K42			O							0	1	0	1	0	1	
K43				O						1	1	0	1	0	1	
K44					O					0	0	1	1	0	1	
K45						O				1	0	1	1	0	1	
K46							O			0	1	1	1	0	1	
K47								O		1	1	1	1	0	1	
K48	O								C6	0	0	0	0	1	1	
K49		O								1	0	0	0	1	1	
K50			O							0	1	0	0	1	1	
K51				O						1	1	0	0	1	1	
K52					O					0	0	1	0	1	1	
K53						O				1	0	1	0	1	1	
K54							O			0	1	1	0	1	1	
K55								O		1	1	1	0	1	1	
K56	O								C5 & C6	0	0	0	1	1	1	
K57		O								1	0	0	1	1	1	
K58			O							0	1	0	1	1	1	
K59				O						1	1	0	1	1	1	
K60					O					0	0	1	1	1	1	
K61						O				1	0	1	1	1	1	
K62							O			0	1	1	1	1	1	
K63								O		1	1	1	1	1	1	



OUTPUT WAVEFORMS

Figure 1 : Data format of Dout output ; REF = Reference time ; T0 and T1 = Toggle bits ; S0 , S1 and S2 = System address ; A , B , C , D , E and F = Command bits.

(a) Flash mode : transmission with 2 toggle bits and 3 address bits , followed by 6 command bits (pulses are flashed).

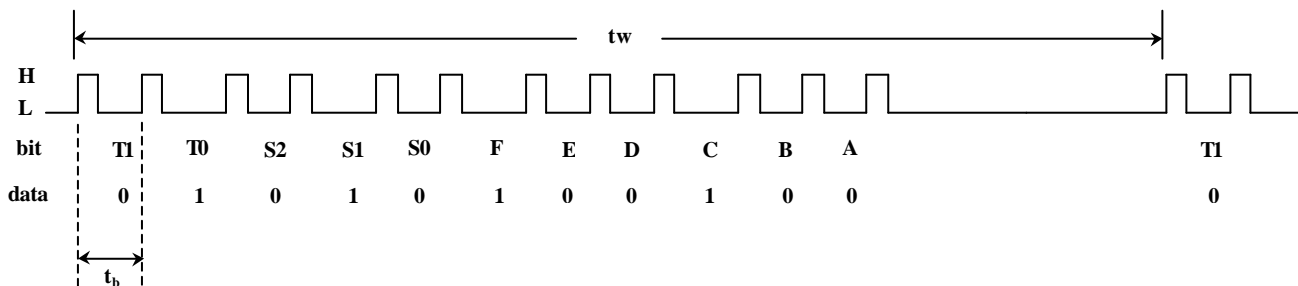

Flashed pulse

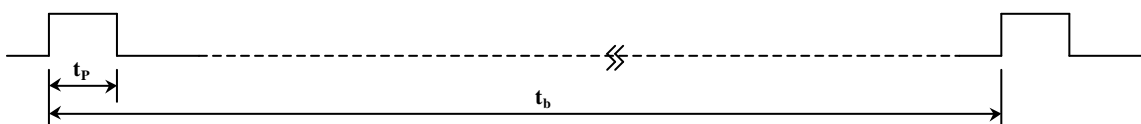

(b) Modulated mode : transmission with reference time , 1 toggle bit and 3 address bits , followed by 6 command bits (pulses are modulated).

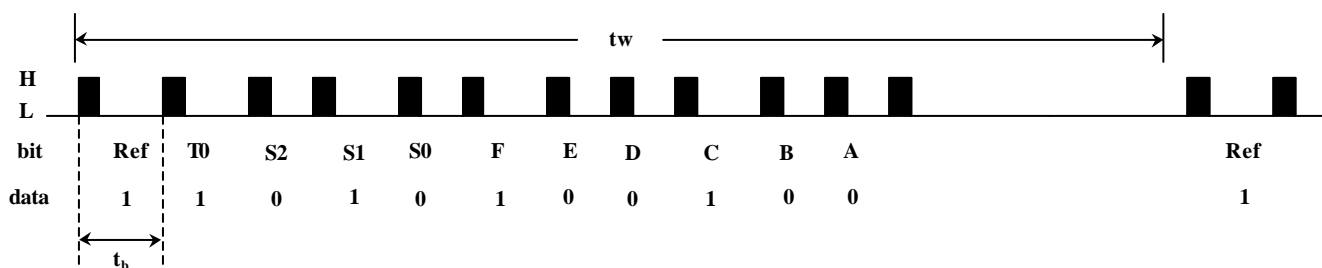

Modulated pulse 【 $t_{pw} = (5 \times t_M) + t_{MH}$ 】

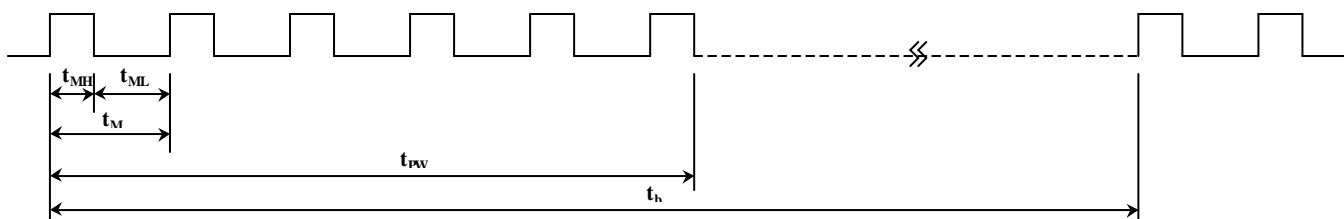



IR TV/VCD TRANSMITTER
IR CONTROL IC

IR CONTROL

M3014

Figure 2 : Single key – Stroke sequence.

Debounce time : $t_{DB} = 4 \text{ to } 9 \times T_0$

Start time : $t_{ST} = 5 \text{ to } 10 \times T_0$

Minimum release time : $t_{REL} = T_0$

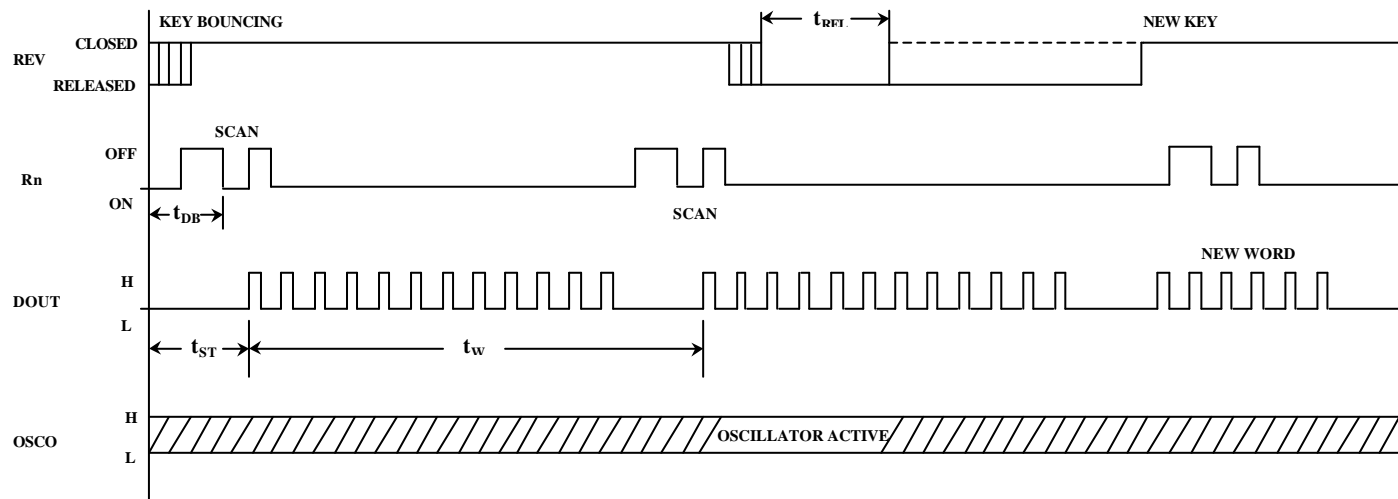
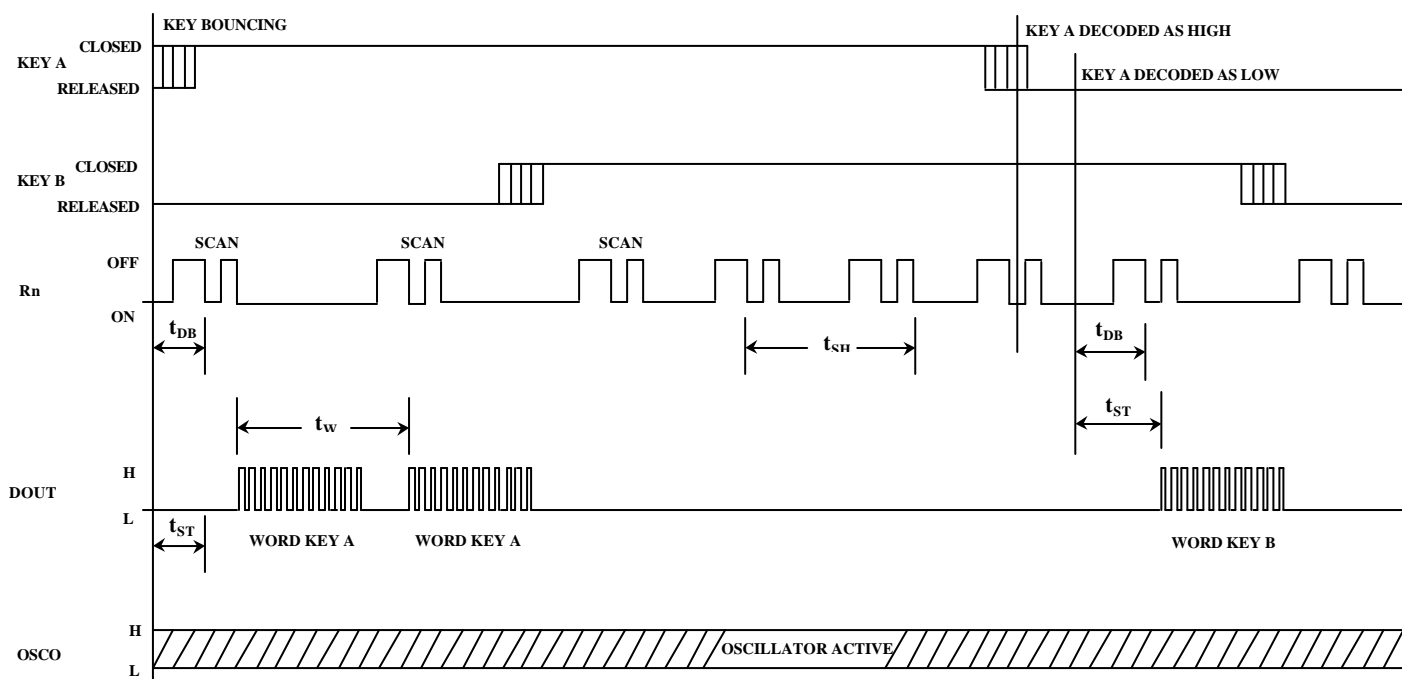

Figure 3 : Multiple key-stroke sequence.

Scanrate multiple key-stroke : $t_{SM} = 8 \text{ TO } 10 \times T_0$





IR TV/VCD TRANSMITTER
IR CONTROL IC

APPLICATION DIAGRAM 參考電路圖

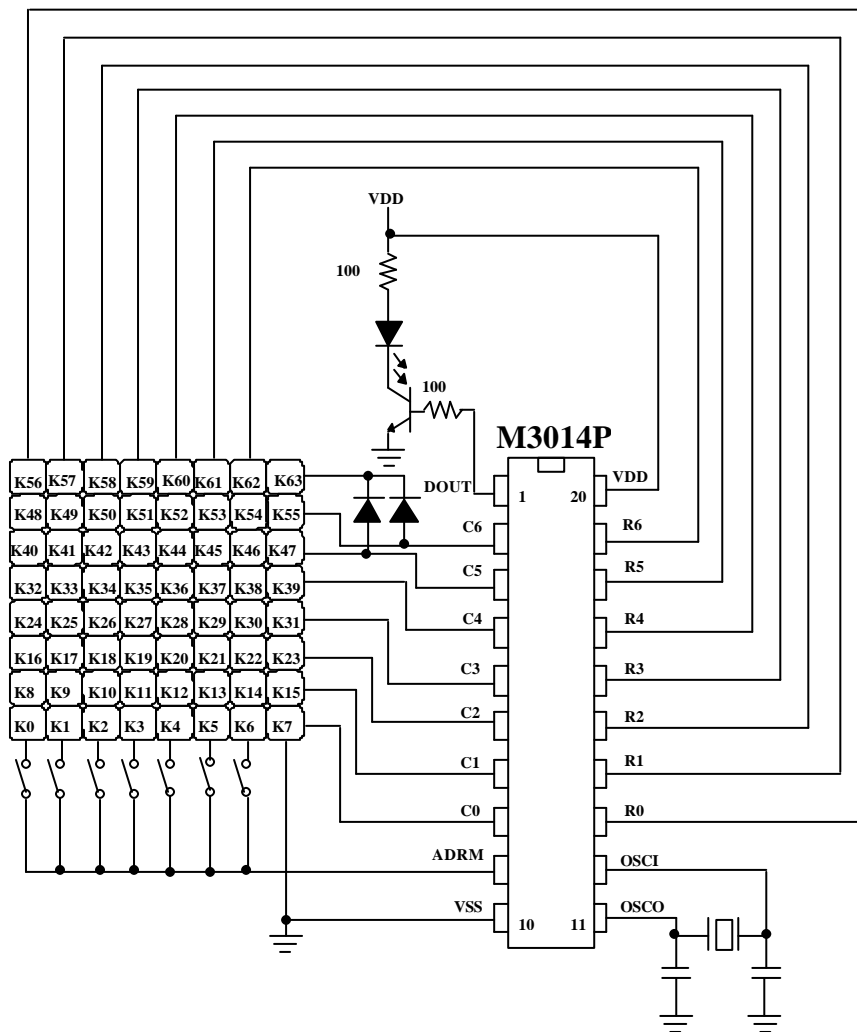

* All specs and applications shown above subject to change without prior notice.
(以上電路及規格僅供參考,本公司得逕行修正)